

Montageanleitung Komplett Dusche "Astoria"

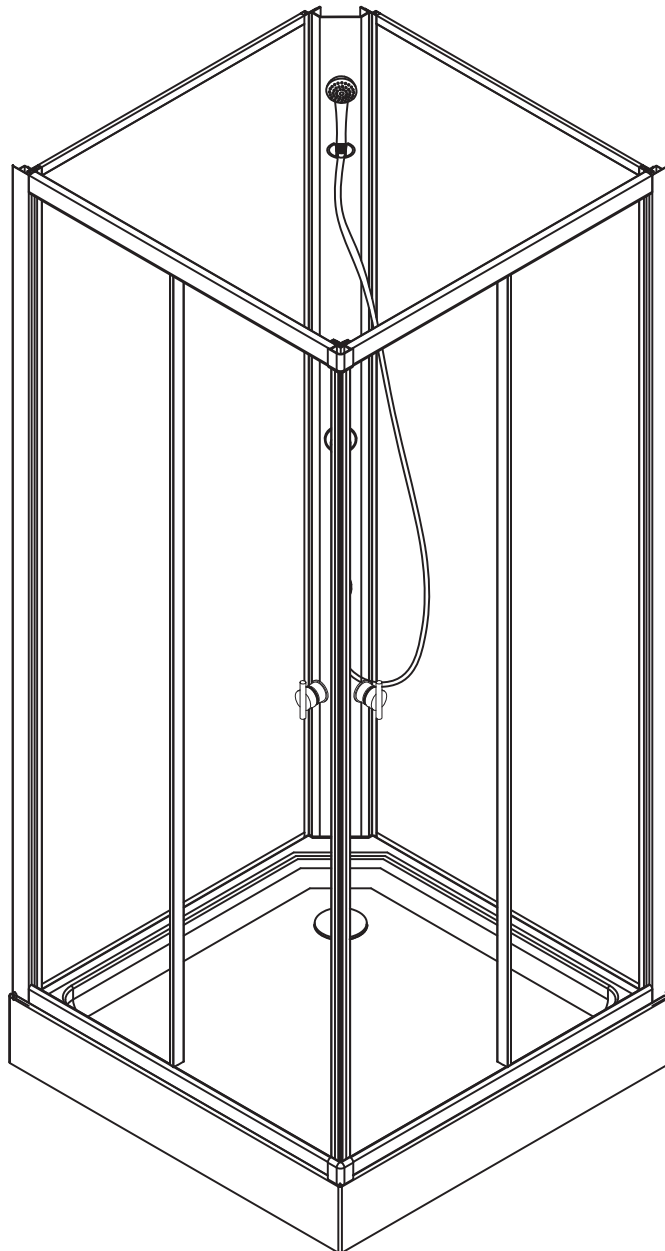

800 x 800 x 1950 mm
Artikelnummer: DM2013 1152013

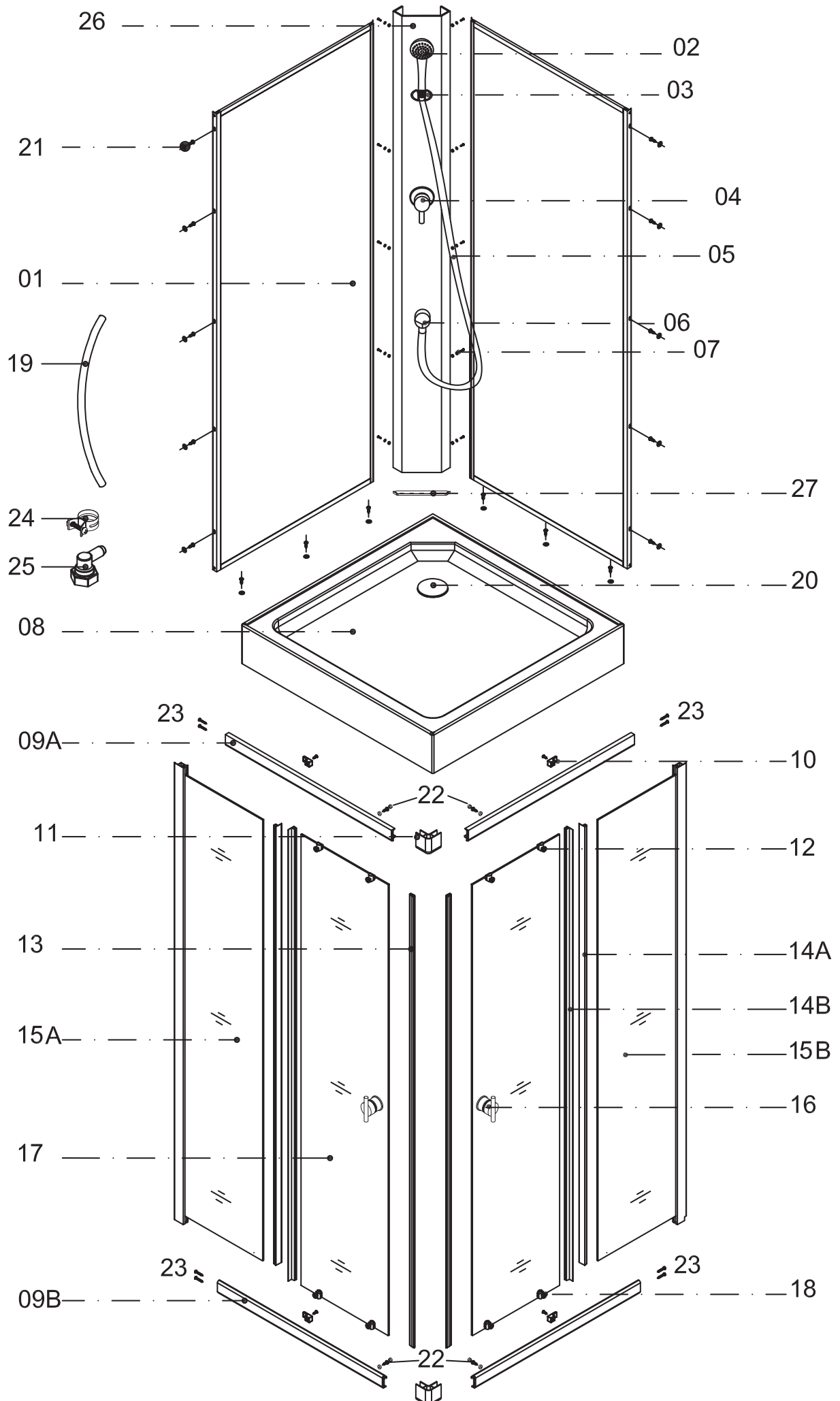



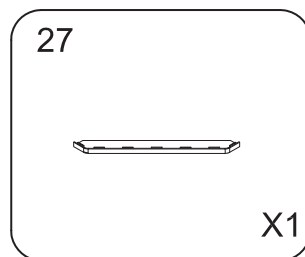
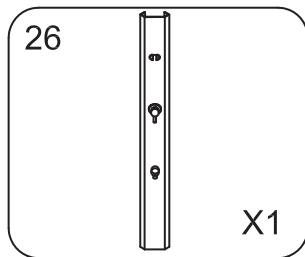
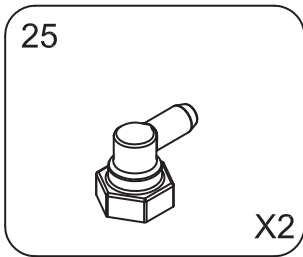
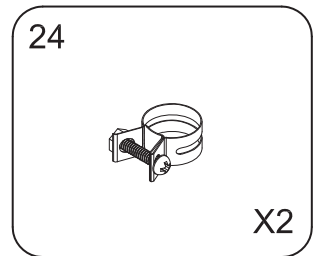
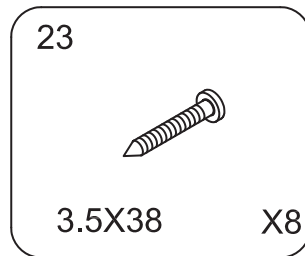
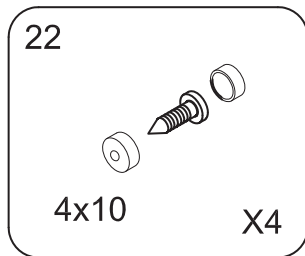
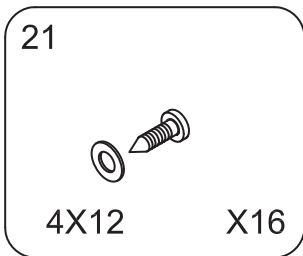
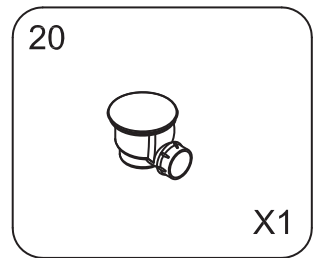
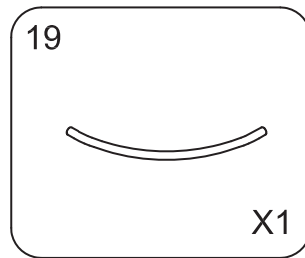
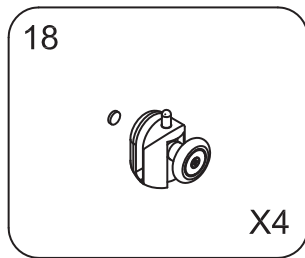
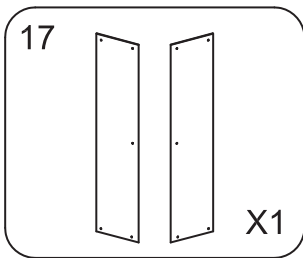
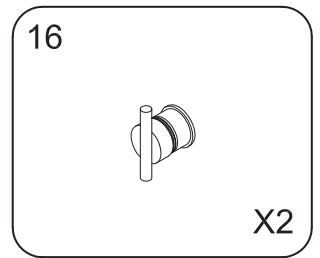
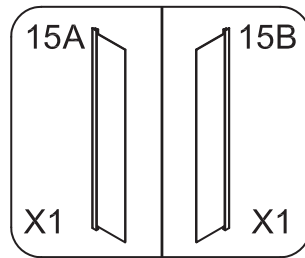
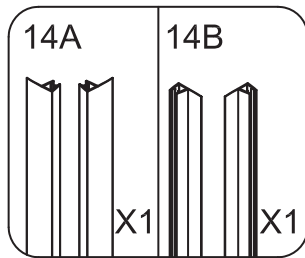
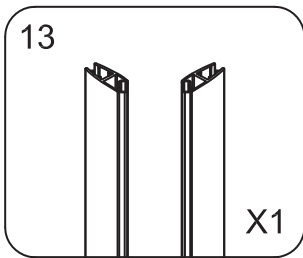
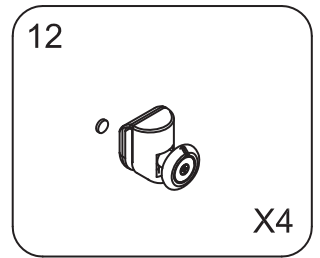
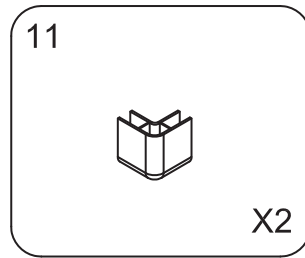
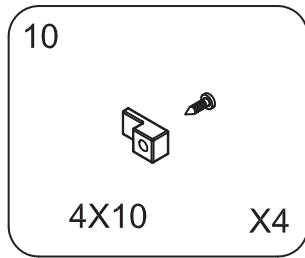
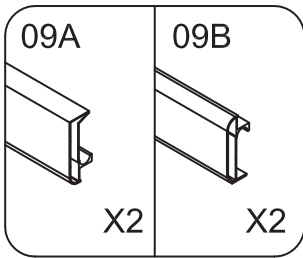
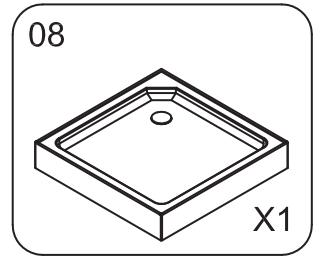
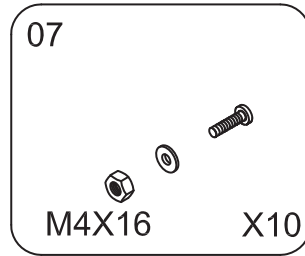
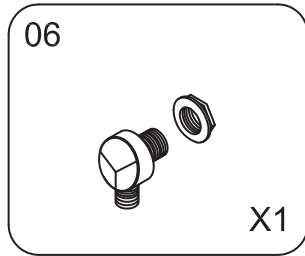
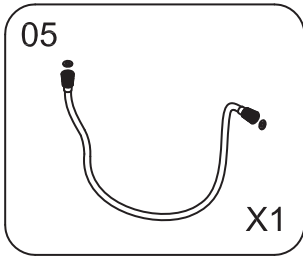
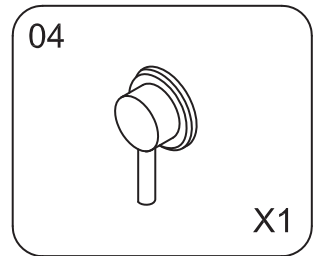
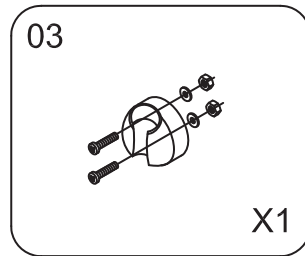
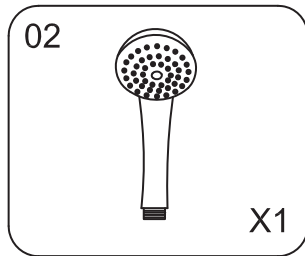
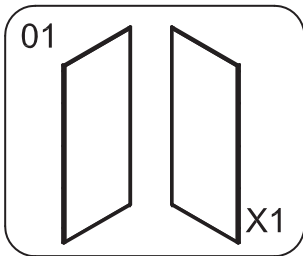

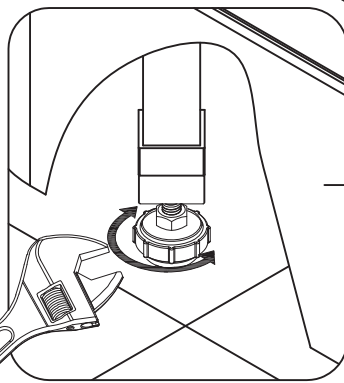
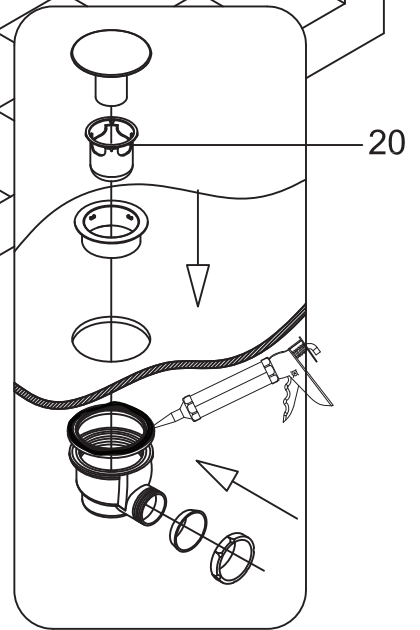
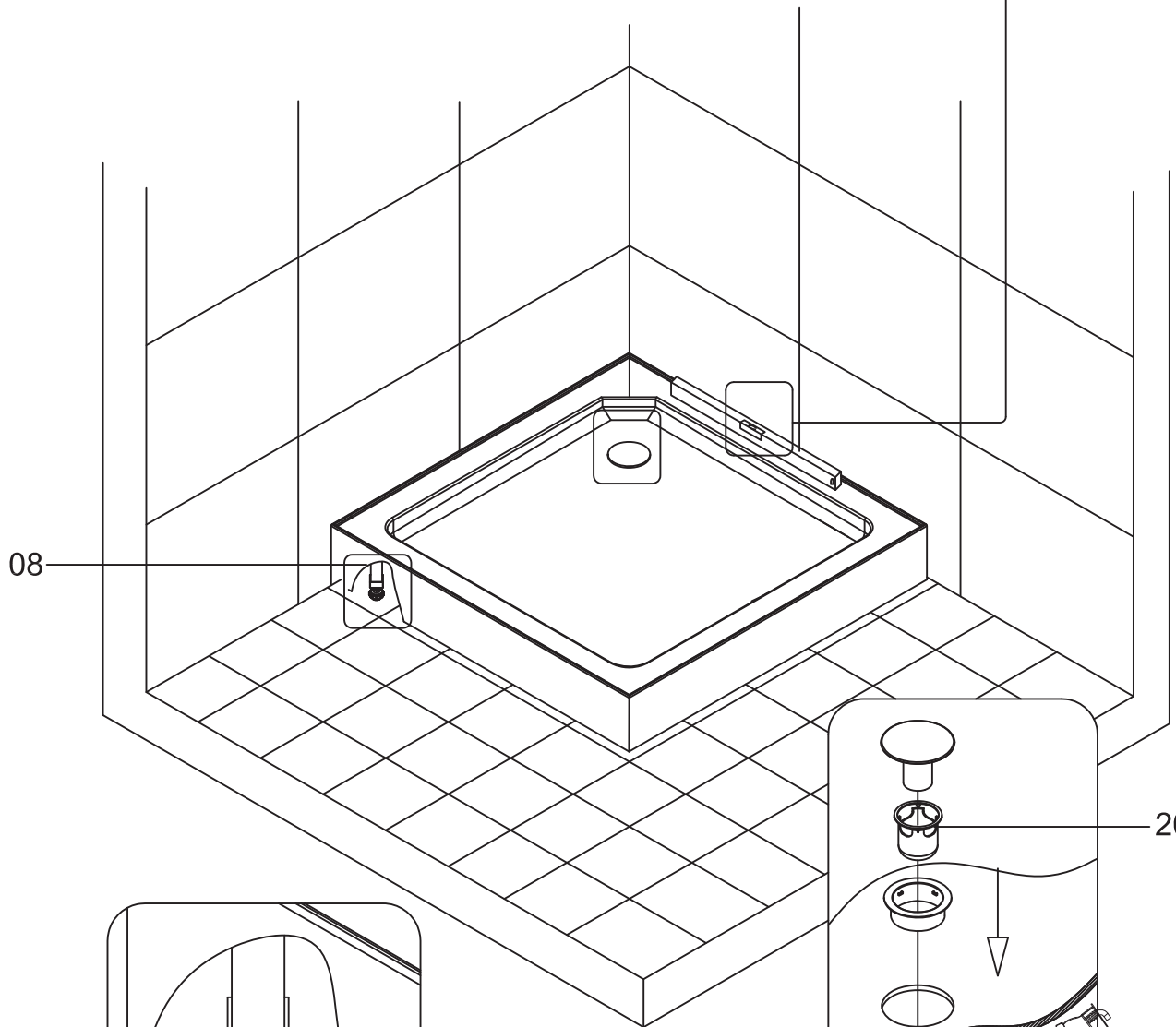
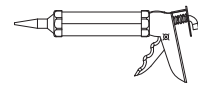
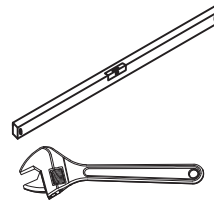
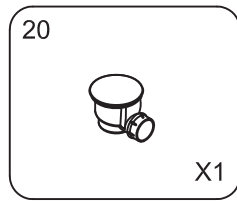
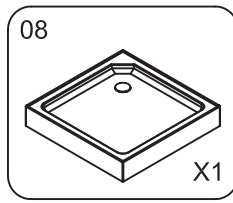

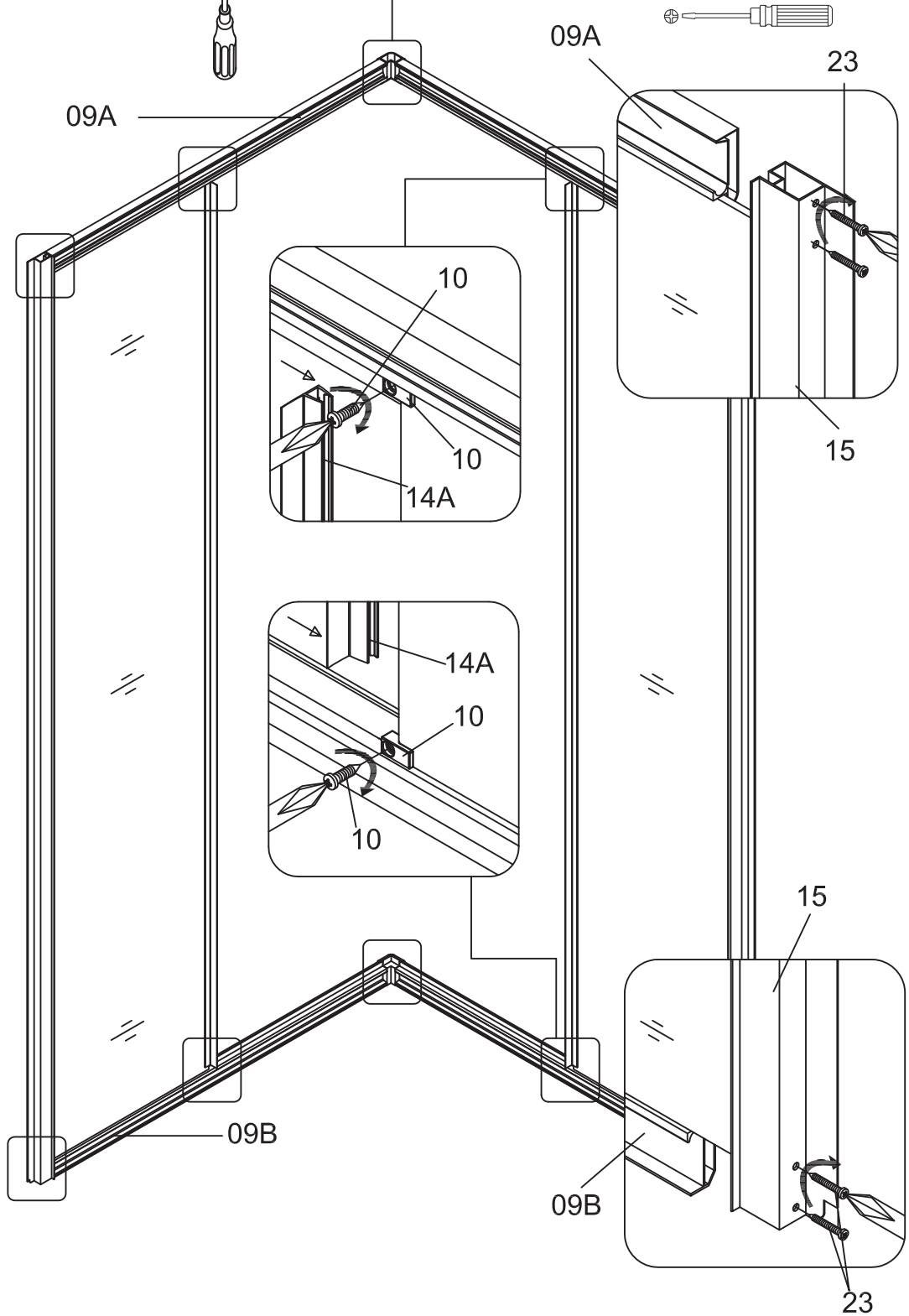
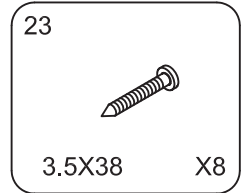
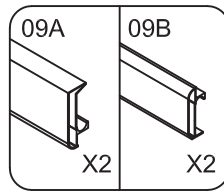
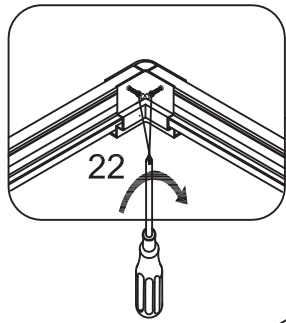
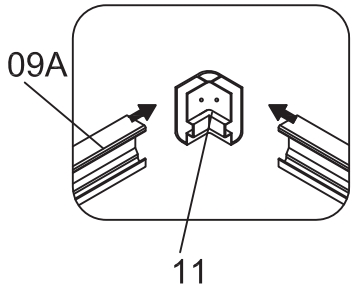
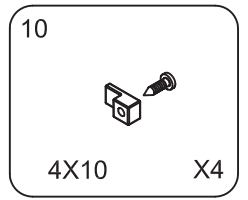
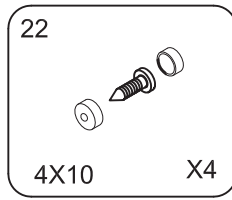
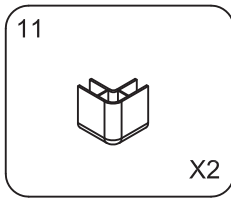
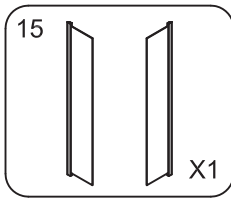
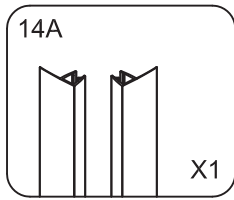

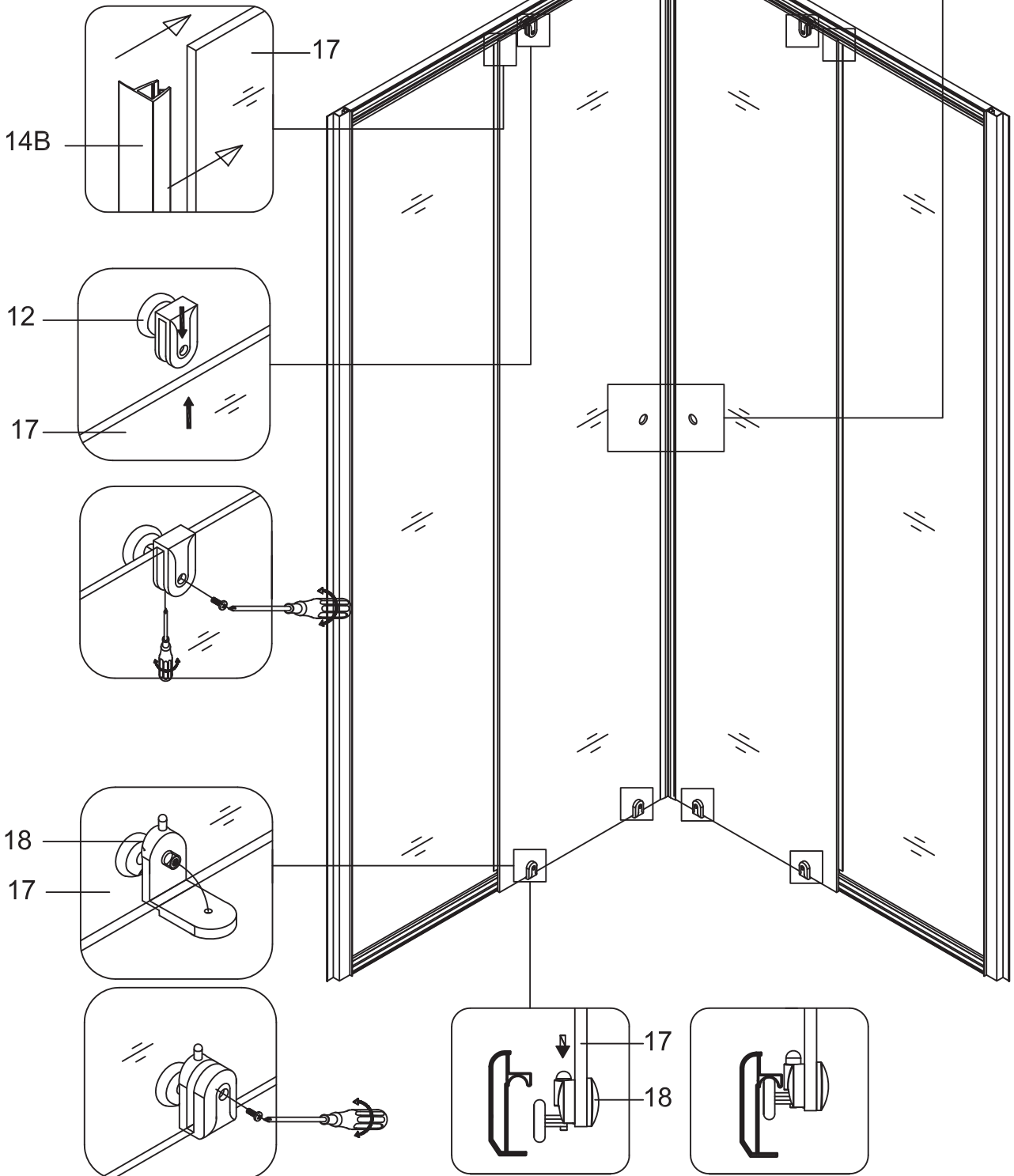
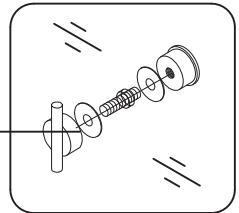
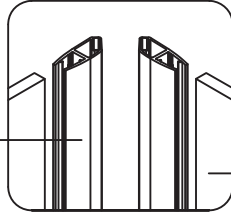
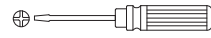
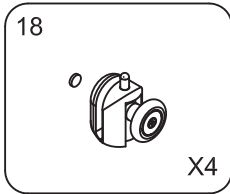
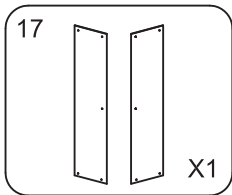
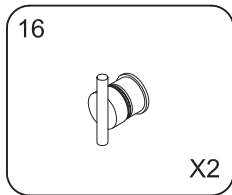
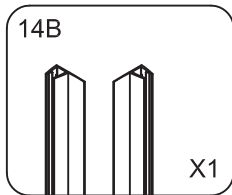
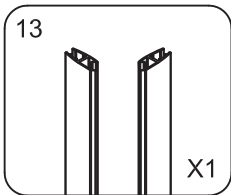
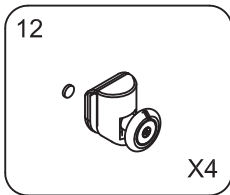

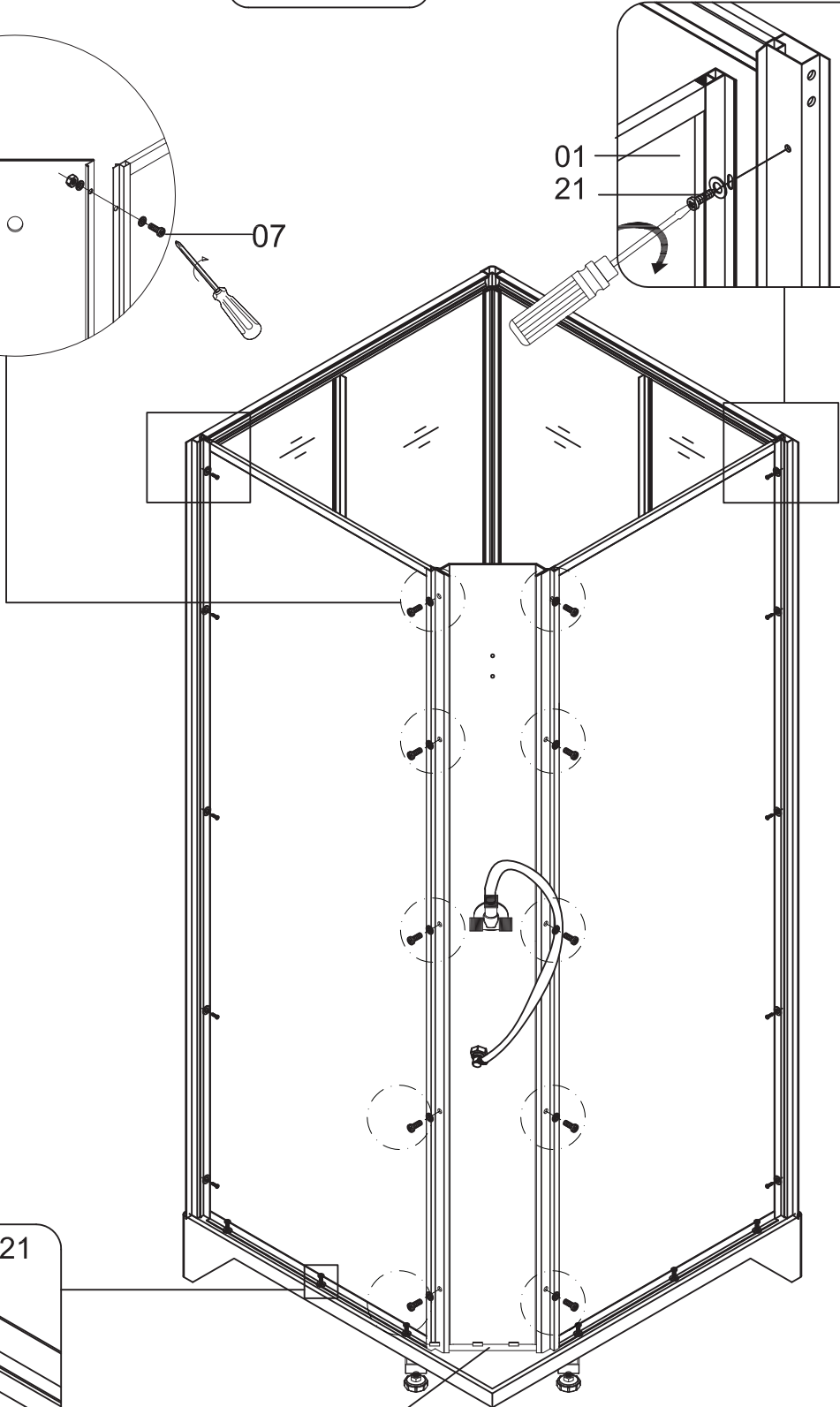
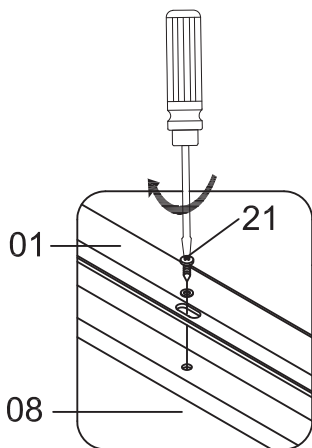
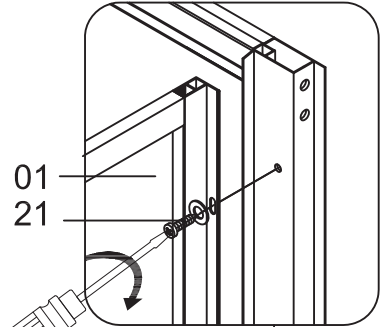
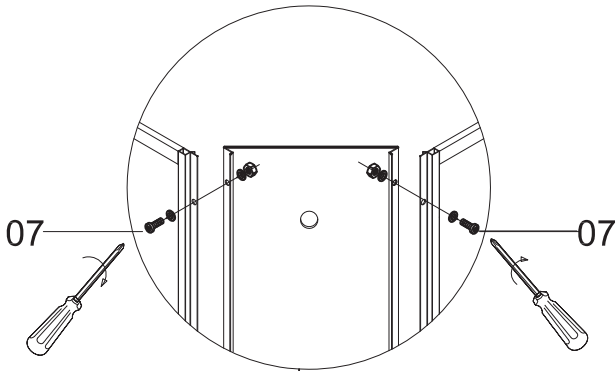
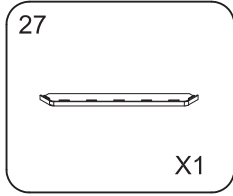
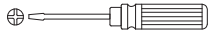
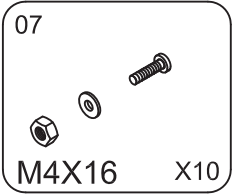
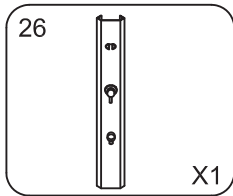
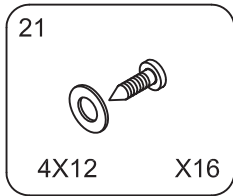
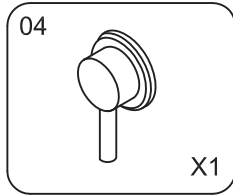
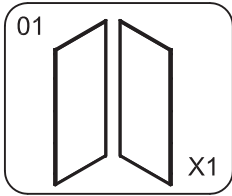

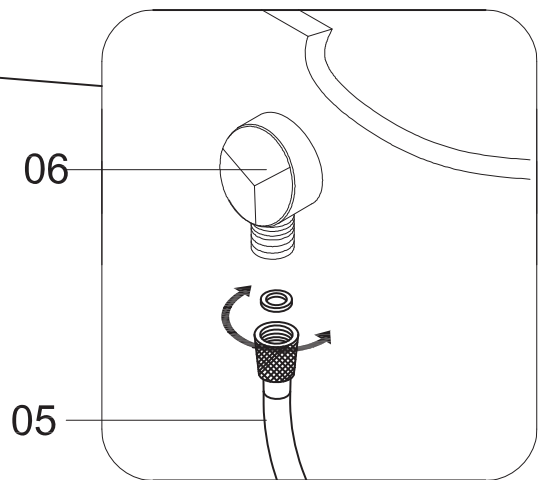
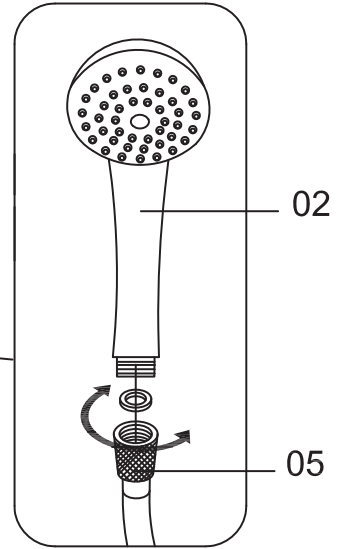
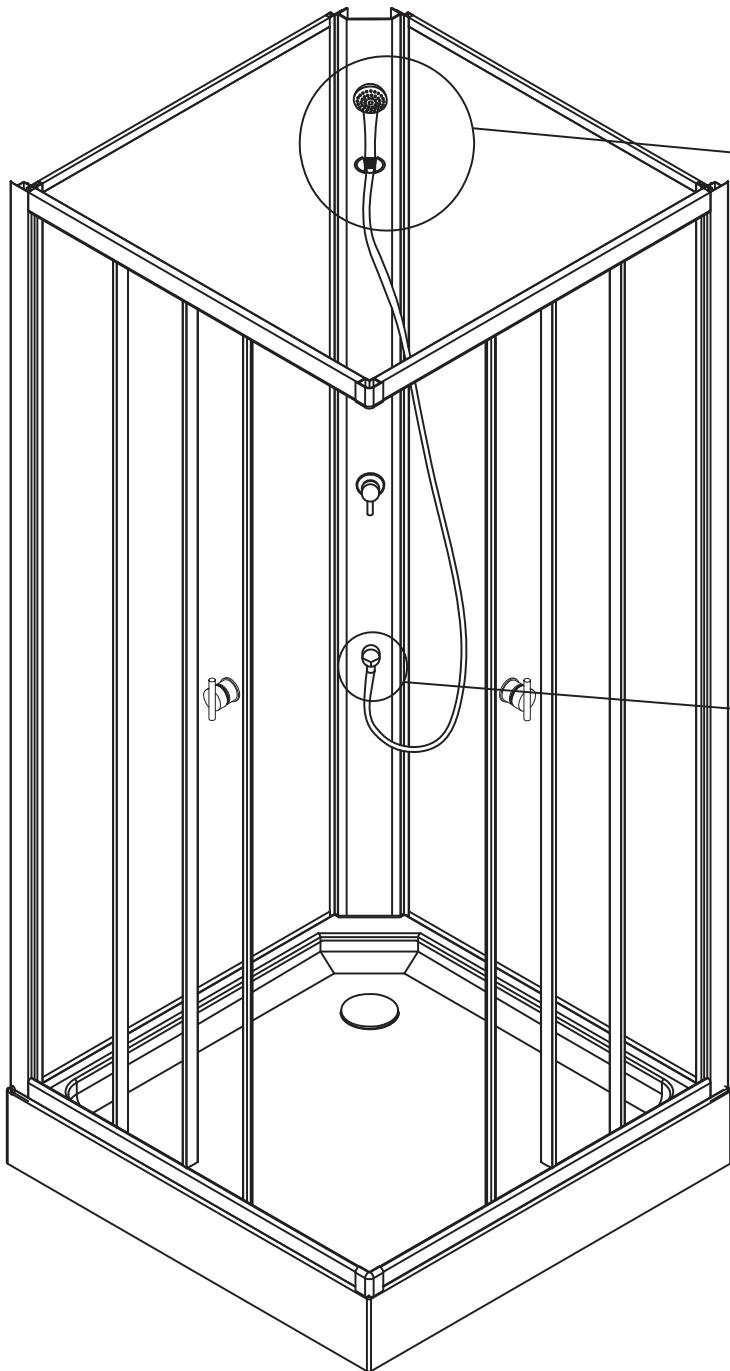
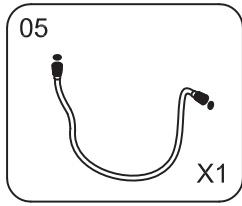
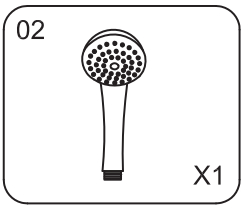

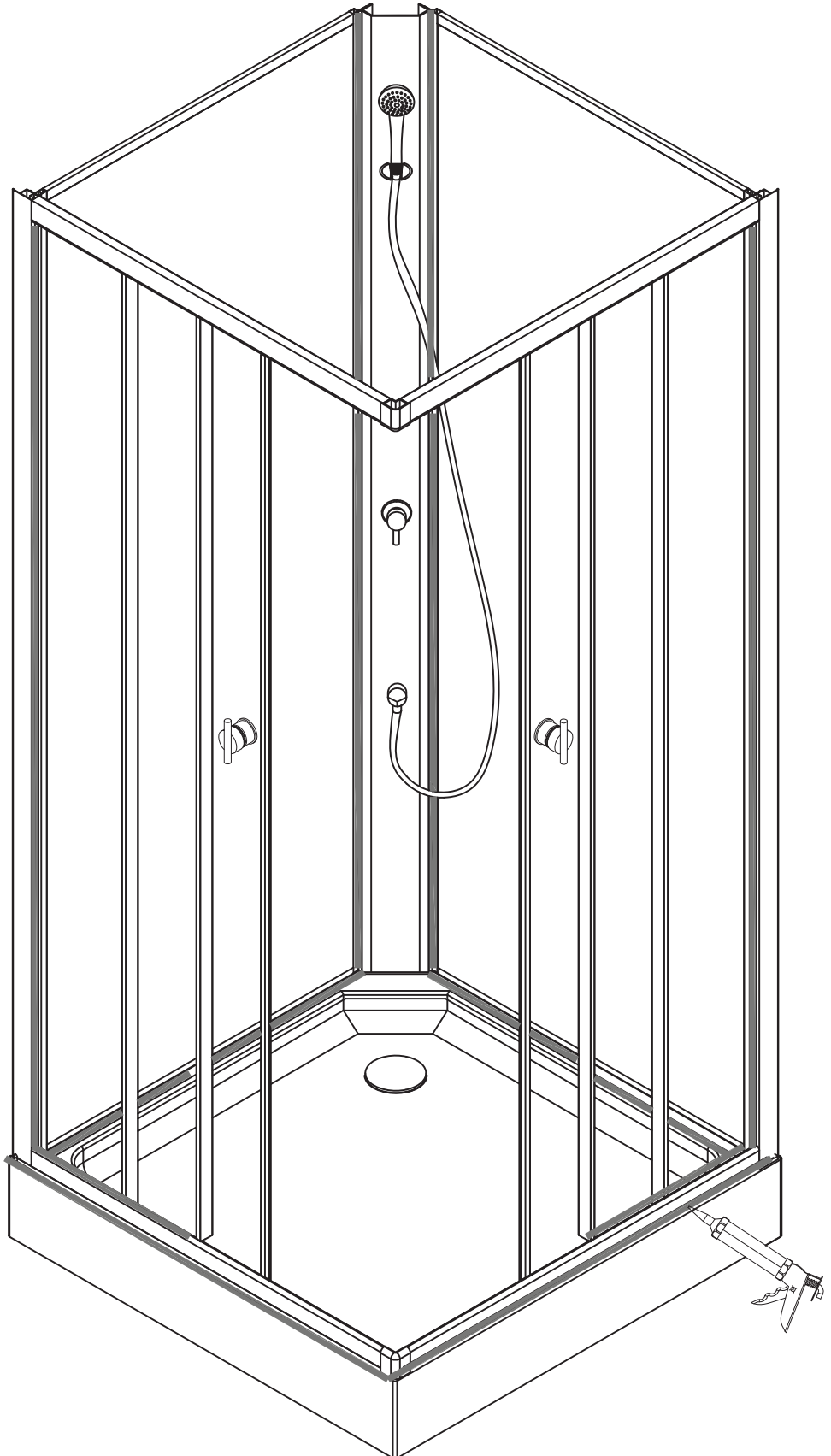
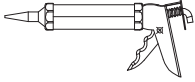



 16							
Dushmeister GmbH & Co. KG An der Strusbek 52a 22926 Ahrensburg bei Hamburg Deutschland							
Duschkabine 1152013 Leistungserklärung: KF1610SC115201300 EN 14428:2004 + A1:2008 Duschkabine aus Aluminium und Glas Verwendungszweck: Körperhygiene <table border="0"> <tr> <td>Reinigbarkeit:</td> <td>Bestanden</td> </tr> <tr> <td>Brucheigenschaften:</td> <td>Bestanden</td> </tr> <tr> <td>Dauerhaftigkeit:</td> <td>Bestande</td> </tr> </table>		Reinigbarkeit:	Bestanden	Brucheigenschaften:	Bestanden	Dauerhaftigkeit:	Bestande
Reinigbarkeit:	Bestanden						
Brucheigenschaften:	Bestanden						
Dauerhaftigkeit:	Bestande						

 16					
Dushmeister GmbH & Co. KG An der Strusbek 52a 22926 Ahrensburg bei Hamburg Deutschland					
Duschkabine 1152013 Leistungserklärung: KF1610SC115201300 EN 14527:2006 + A1:2010 CL1+CL2 Duschtasse aus ABS und Acryl Maße: 800 x 800 x 160 mm Verwendungszweck: Körperhygiene <table border="0"> <tr> <td>Reinigbarkeit:</td> <td>Bestanden</td> </tr> <tr> <td>Dauerhaftigkeit:</td> <td>Bestanden</td> </tr> </table>		Reinigbarkeit:	Bestanden	Dauerhaftigkeit:	Bestanden
Reinigbarkeit:	Bestanden				
Dauerhaftigkeit:	Bestanden				

 16							
Dushmeister GmbH & Co. KG An der Strusbek 52a 22926 Ahrensburg bei Hamburg Germany							
Shower cabin 1152013 Declaration of performance: N° KF1610SC115201300 EN 14428:2004 + A1:2008 Shower enclosure made of aluminium / glass Intended use : personal hygiene <table border="0"> <tr> <td>Cleanability:</td> <td>Pass</td> </tr> <tr> <td>Impact resistance & Shatter property:</td> <td>Pass</td> </tr> <tr> <td>Durability:</td> <td>Pass</td> </tr> </table>		Cleanability:	Pass	Impact resistance & Shatter property:	Pass	Durability:	Pass
Cleanability:	Pass						
Impact resistance & Shatter property:	Pass						
Durability:	Pass						

 16					
Dushmeister GmbH & Co. KG An der Strusbek 52a 22926 Ahrensburg bei Hamburg Germany					
Shower cabin 1152013 Declaration of performance: N° KF1610SC115201300 EN 14527:2006 + A1:2010 CL1+CL2 Shower tray made of ABS / acrylic Dimensions: 800 x 800 x 160 mm Intended use: personal hygiene <table border="0"> <tr> <td>Cleanability:</td> <td>Pass</td> </tr> <tr> <td>Durability:</td> <td>Pass</td> </tr> </table>		Cleanability:	Pass	Durability:	Pass
Cleanability:	Pass				
Durability:	Pass				