

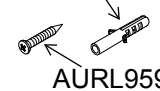
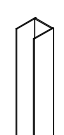

01 AURL967

 AURL959
 ST4X25 X3

02 AURL1327

 X1

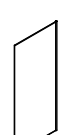
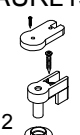
03 AURL1328

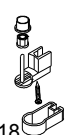
 X1

04

 X1

05 AURL1324

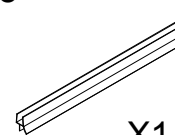
 ST4X12
 ST4X18 X1

06 AURL1324

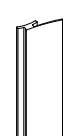
 ST4X18 X1

07 AURL953

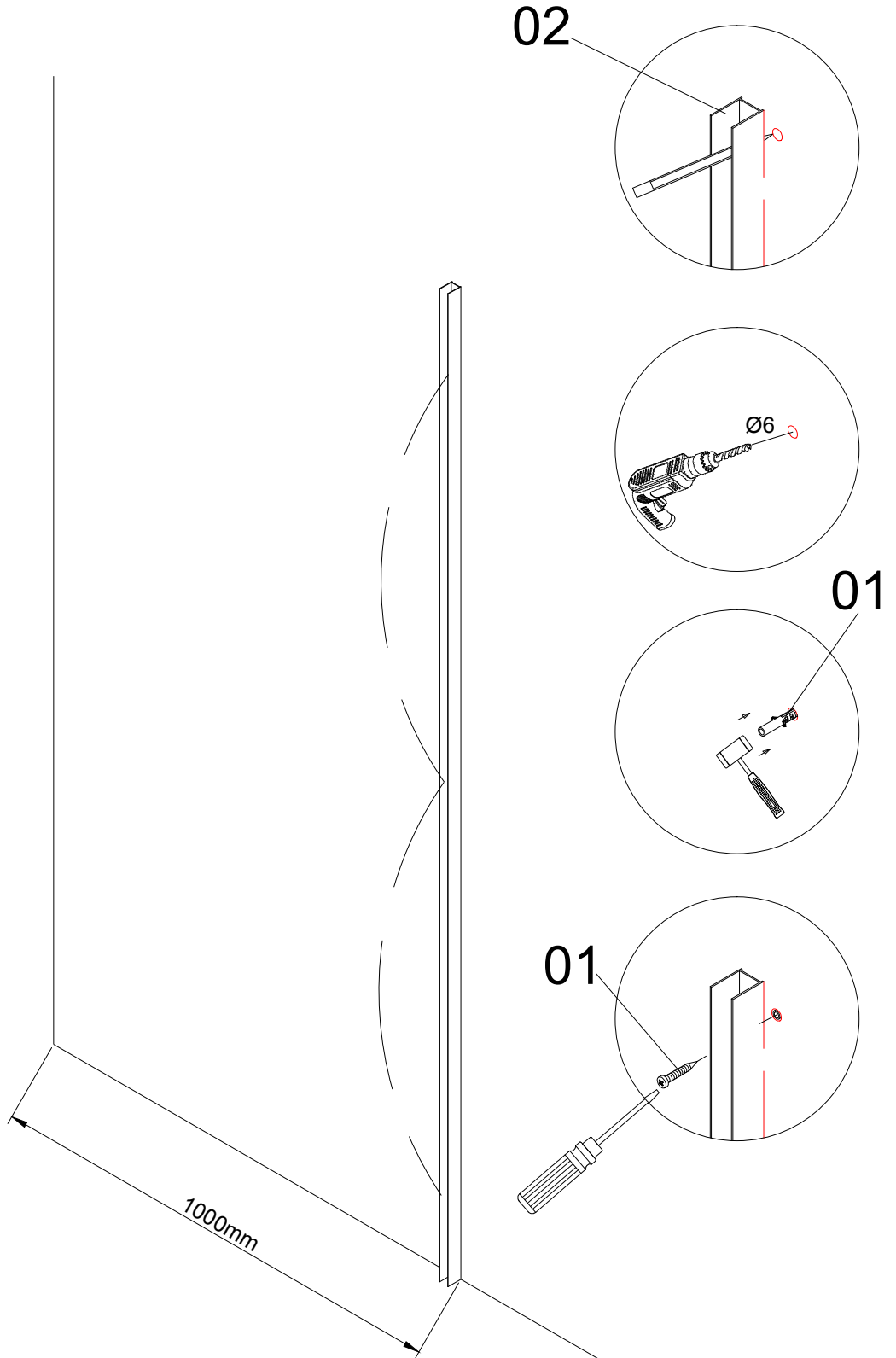
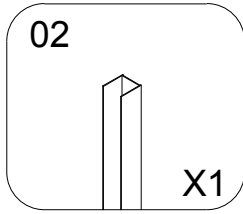
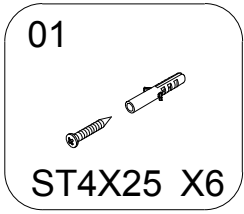
 AURL973
 ST4X10 X3

08 AURL1325

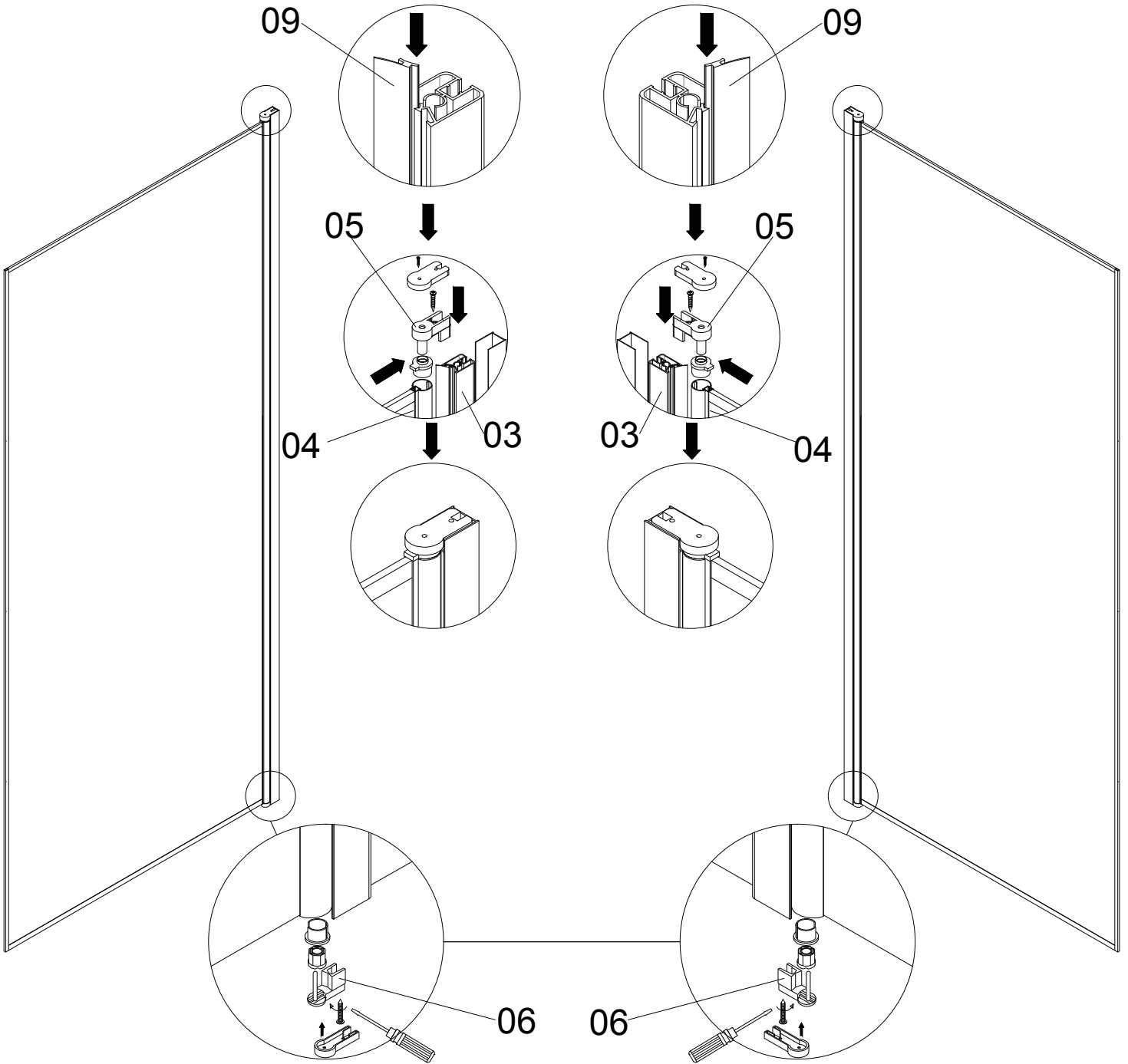
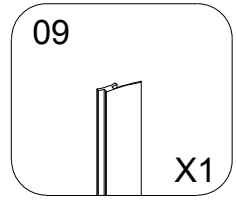
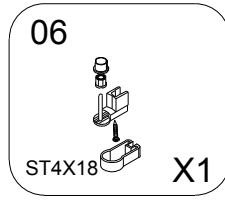
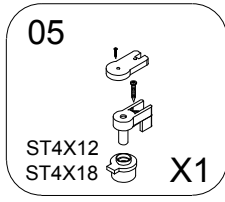
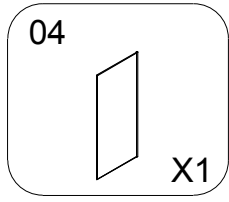
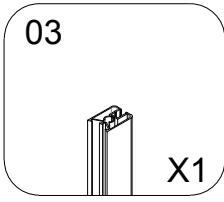
 X1

09 AURL1326

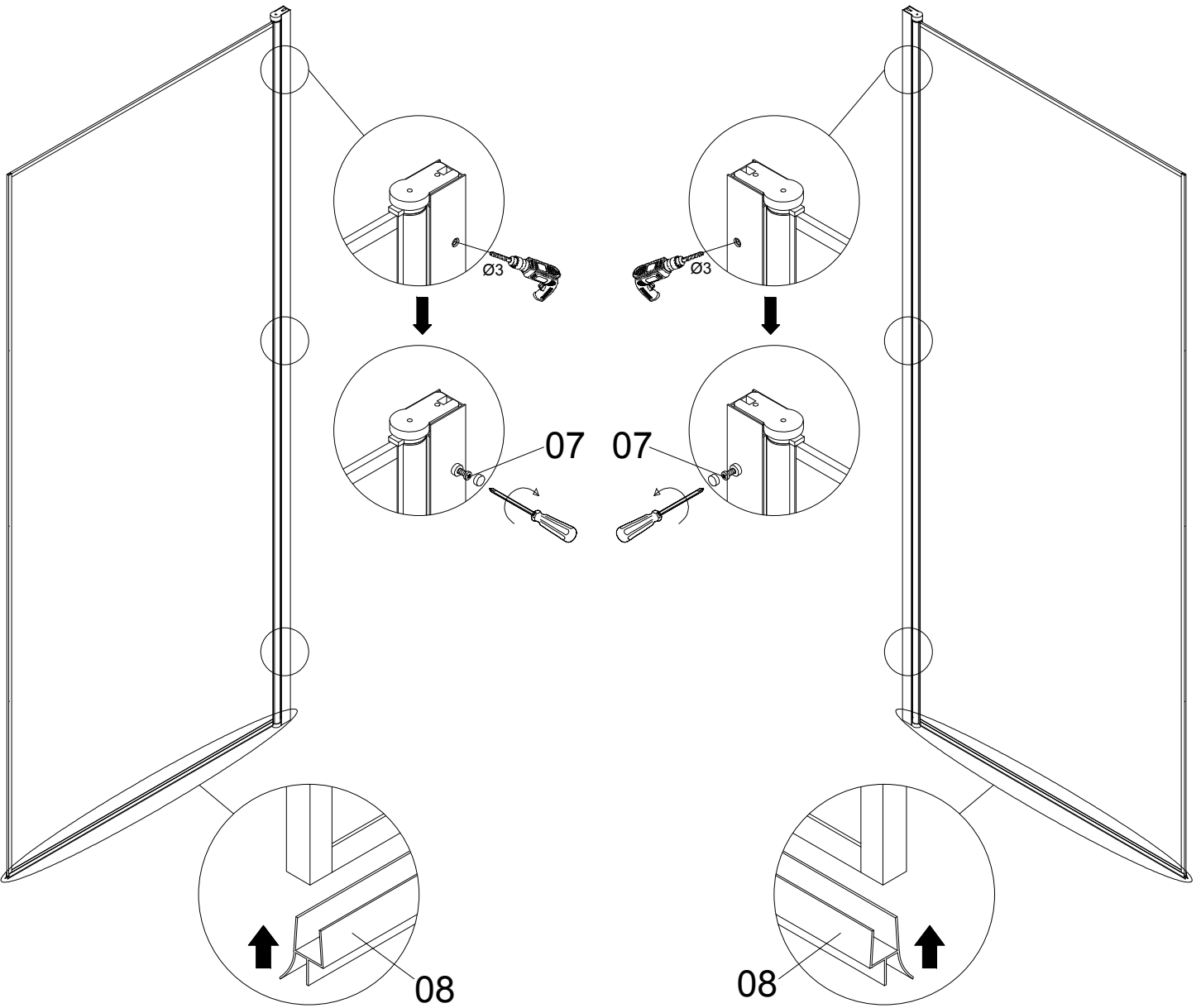
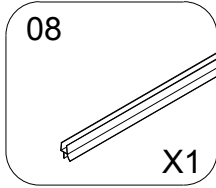
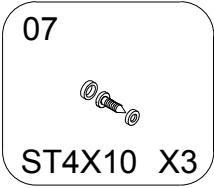
 X1



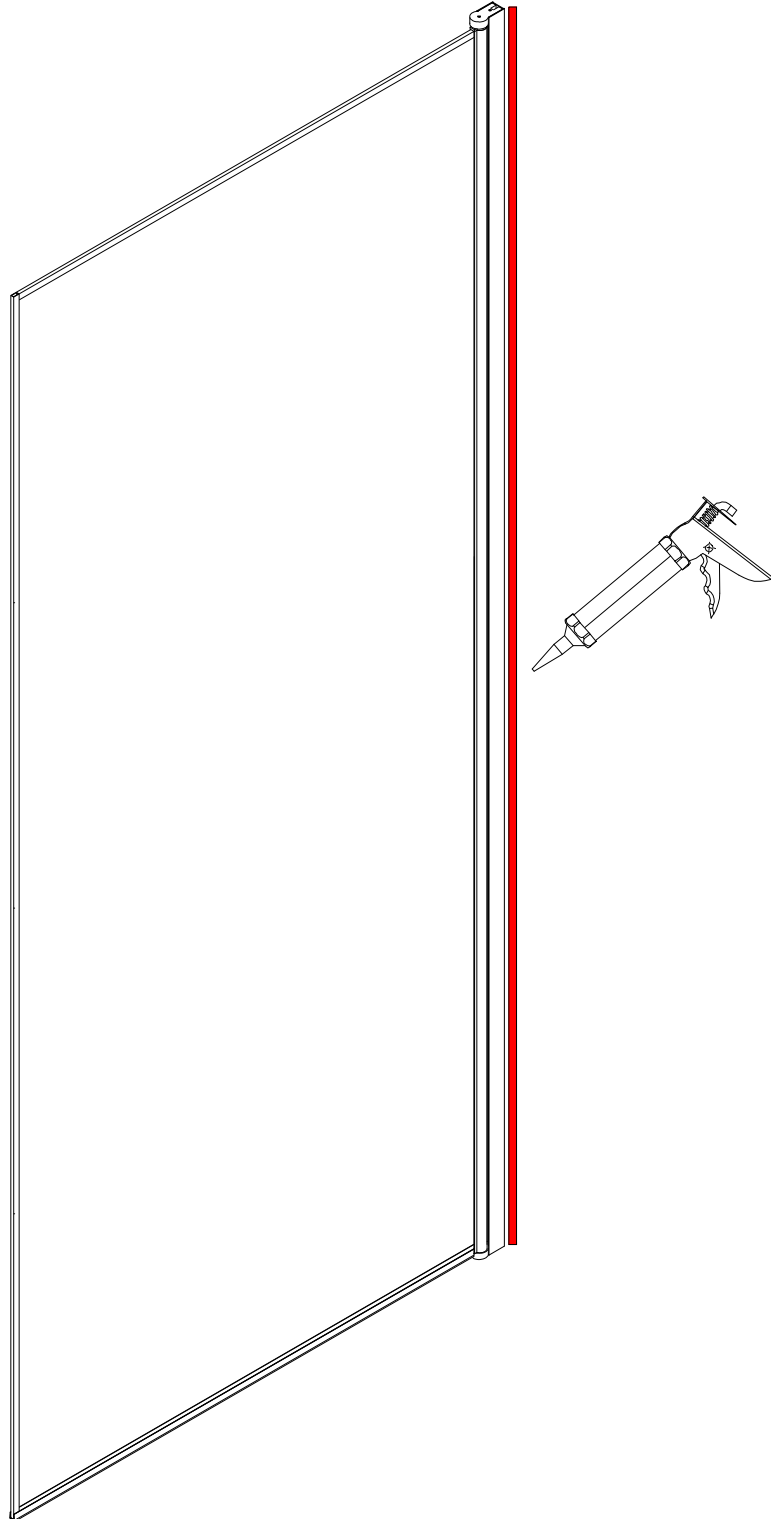
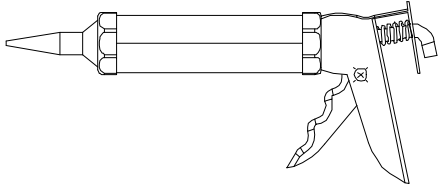





DÉCLARATION DES PERFORMANCES

N o DoP_FAC_024

1. Code d'identification du produit Type : *PAROIS DARK EDGE*

Par extension, la présente déclaration des performances est applicable aux produits détaillés en annexe.

2. Usage(s) prévu(s): PAROIS DE DOUCHE POUR HYGIENE PERSONNEL-PH.....

3. Fabricant :AURLANE 32 rue Washington 75008 PARIS.....

4. Mandataire :Non applicable.....

5. Système(s) d'évaluation et de vérification de la constance des performances: système 4.....

6a. Norme harmonisée: EN14428:2004

Organisme(s) notifié(s) : Non applicable

6b. Document d'évaluation européen Non applicable

Evaluation technique européenne Non applicable

Organisme d'évaluation technique Non applicable

Organisme(s) notifié(s) Non applicable

7. Performances déclarées

Caractéristiques essentielles	Performances	Spécifications techniques harmonisées
Aptitude au nettoyage	Exigences satisfaites	EN14428:2004+A1:2008 Clause 4.2
Résistance à l'impact / Propriétés d'éclatement	Exigences satisfaites	EN14428:2004+A1:2008 Clause 4.3
Durabilité	Exigences satisfaites	EN14428:2004+A1:2008 Clause 4.4

Les performances du produit identifié ci-dessus sont conformes aux performances déclarées.

Conformément au règlement (UE) n°305/2011, la présente déclaration des performances est établie sous la seule responsabilité du fabricant mentionné ci-dessus.

Signé au nom du fabricant par:

Sébastien Doumenc
Directeur associé Aurlane
A Paris, le 12/05/2019



ANNEXE 1 références

code_produit	Designation
FAC215	DARK EDGE 90x200 PAROI DE DOUCHE / DARK EDGE 90X200 SHOWER ENCLOSURE
FAC216	DARK EDGE 120x200 PAROI DE DOUCHE / DARK EDGE 120X200 SHOWER ENCLOSURE
FAC217	DARK EDGE 140x200 PAROI DE DOUCHE / DARK EDGE 140X200 SHOWER ENCLOSURE
FAC499	DARK EDGE 100
FAC500	DARK EDGE PIVOTANTE 80
FAC501	DARK EDGE PIVOTANTE 90
FAC502	DARK EDGE COTE FIXE 80
FAC503	DARK EDGE COTE FIXE 90
FAC602	PARE BAIGNOIRE DARK EDGE 130X75

ANEXE 2 MARQUAGE CE

